













Building Decoration **Products**



DD 80		
DD 81		
DD 82		
DD 82A		
DD 83		



DD 84



DB 86















DB 87



DB 88



DD 89

DD 90		
DD 91		
DD 92		
DD 93		
DD 94		
DD 95		



DP 44



DP 46



DP 47



DP 48



DP 50

DP 53



DP 54



DP 55

























DP 60















DP 62



		<p>DP 63</p>
		<p>DP 64</p>
		<p>DP 65</p>
		<p>DP 66</p>
		<p>DP 67</p>

DP 68		
DP 212		
DP 214		
DP 218		
DP 220		
DP 280		

		<p>TT 20</p>
		<p>TT 28</p>
		<p>TT 30</p>
		<p>TT 32</p>
		<p>TT 34</p>

TT 36		
TT 38		
TT 39		
TT 85		
TS 1		
TS 3		



TS 5



TS 6



YS 1



YS 2



YS 3

YS 4



YS 6



YS 7











TM 1

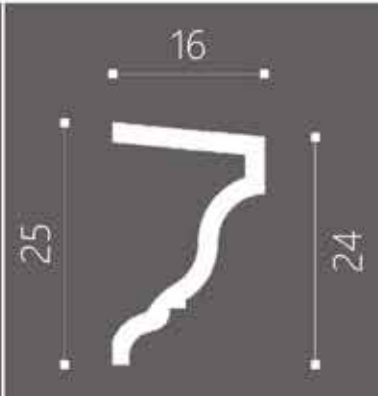

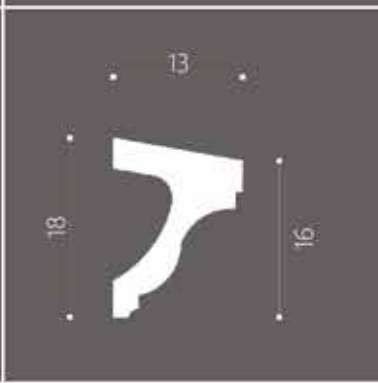
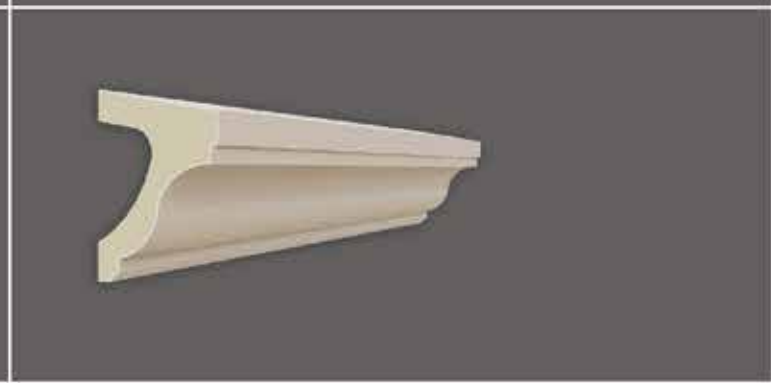
TM 3

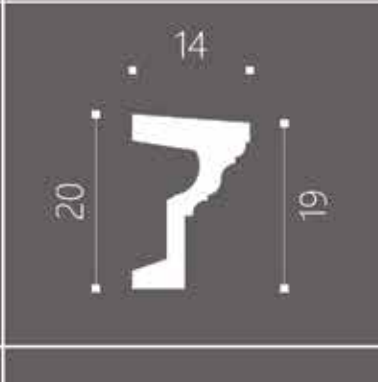

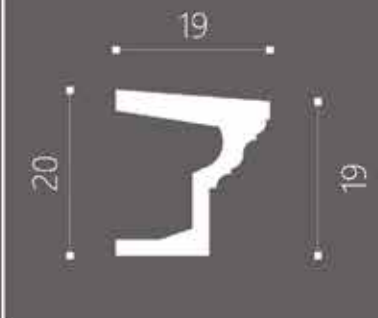
		<p>TM 11</p>
		<p>TM 12</p>
		<p>TM 30</p>
		<p>TM 40</p>
		<p>TM 50</p>

SS 1		
KS 1		
KS 2		
PT 1		
PT 2		



PS 1

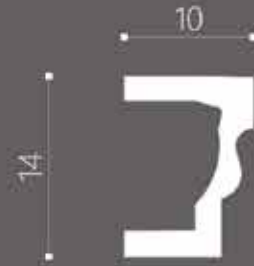

PS 2













PL 1



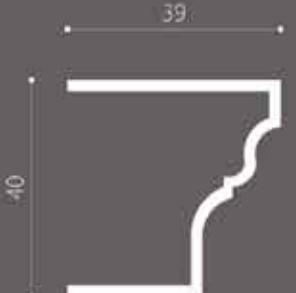

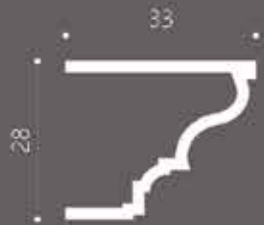

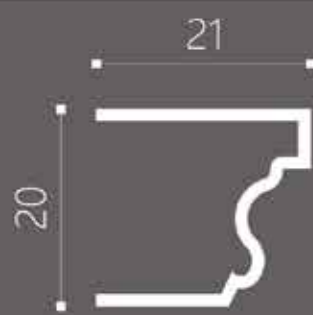



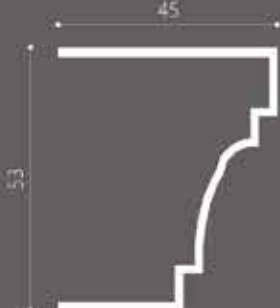



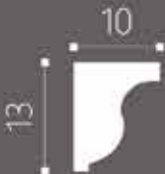



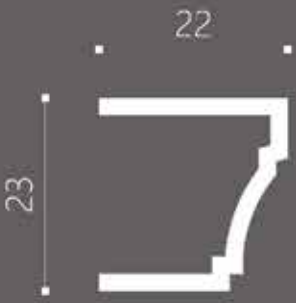

PL 2

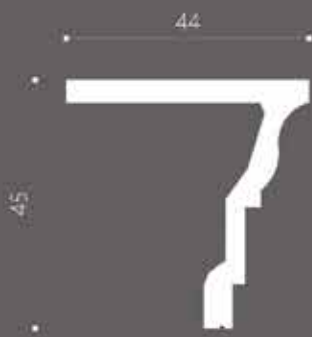

D 1

D 2		
BS 1		
BS 2		
BS 3		
BS 4		

		<p>BS 5</p>
		<p>BS 6</p>
		<p>BS 7</p>
		<p>BS 8</p>
		<p>BS 9</p>

BS 10	 <p>22 23</p>	
BS 11	 <p>26 20</p>	
BS 12	 <p>44 45</p>	
BS 13	 <p>36 50</p>	
BS 14	 <p>30</p>	



BS 15





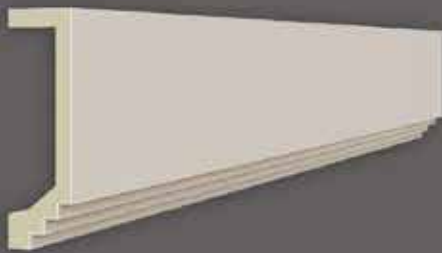







BS 16

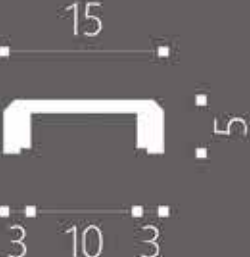

BS 17

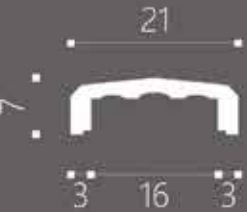

BS 18

HP 01		
HP 02		
HP 10		
HP 16		
HP 24		



HP 35

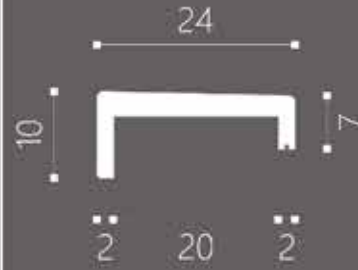

HP 20

L1 SÖVE

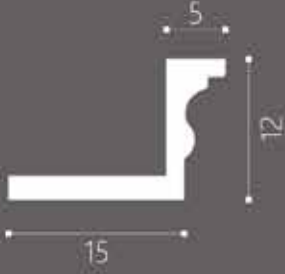

L2 SÖVE

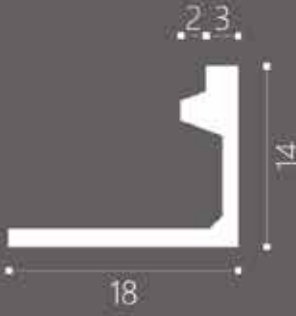

L3 SÖVE

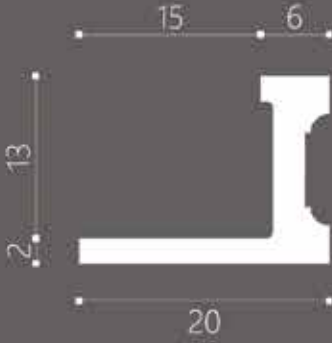

L4 SÖVE



L5 SÖVE

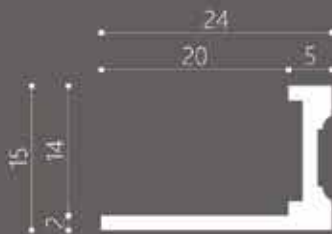

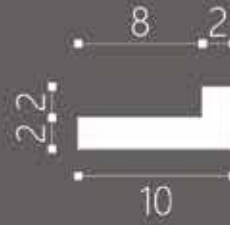

L6 SÖVE

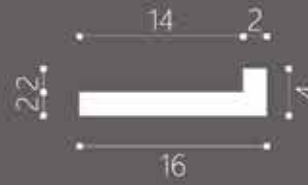

L7 SÖVE

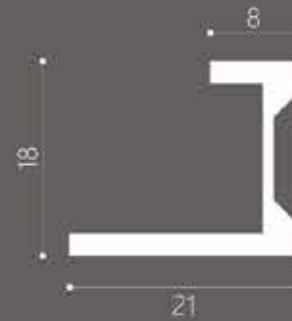

L8 SÖVE

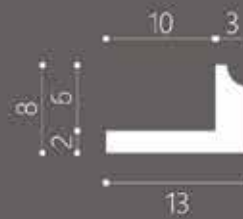

L9 SÖVE



L10 SÖVE

S 11

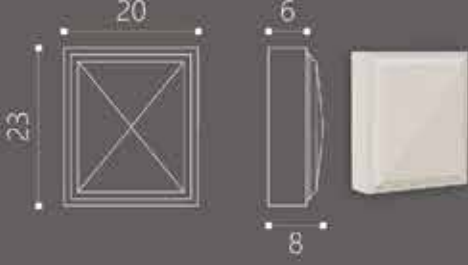

DR 15

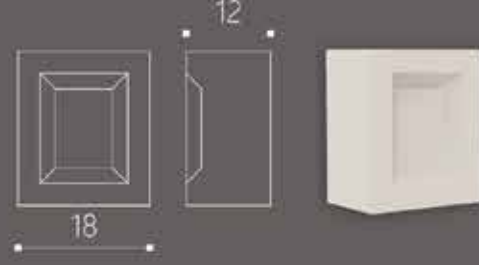

DR 50



DR 4

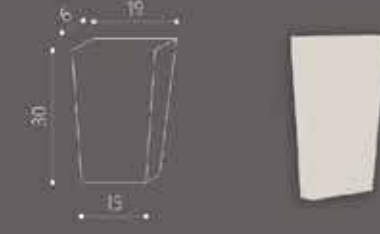

DR 6

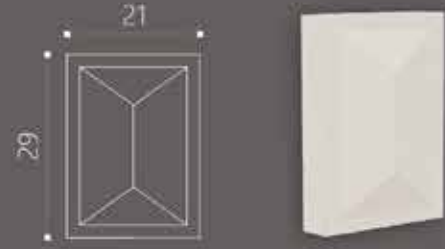

DR 20

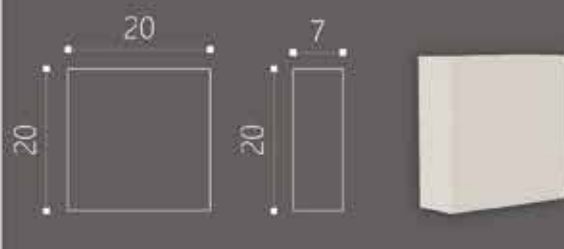

DR 21

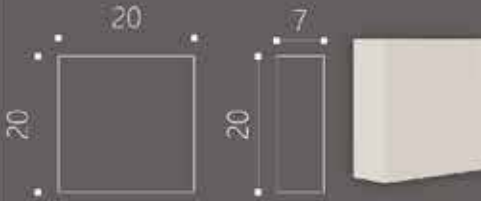

DR 30

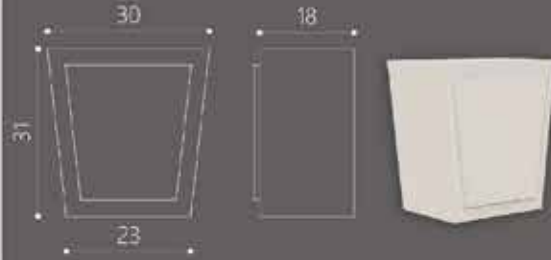

DR 31

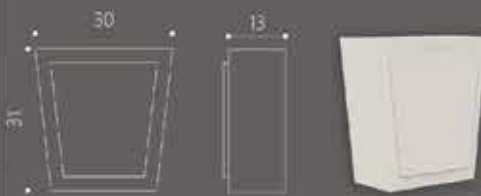

DR 32

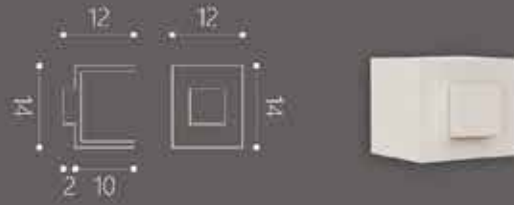

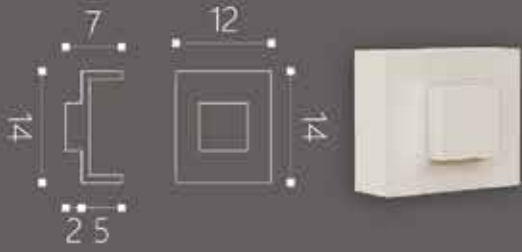

DR 33

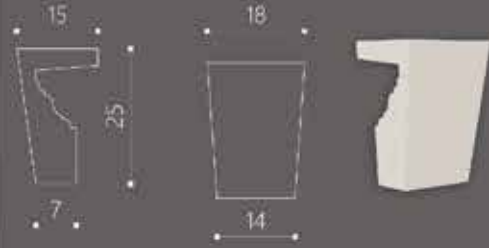

DR 1

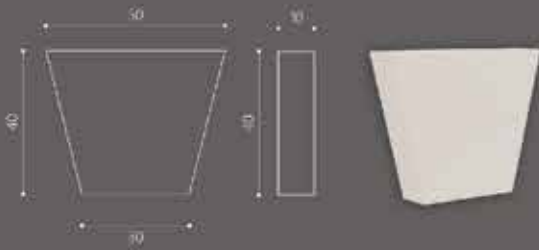

DR 50A



DR 76



DR 5

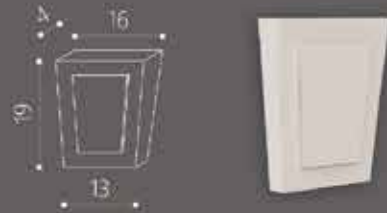

DR 10

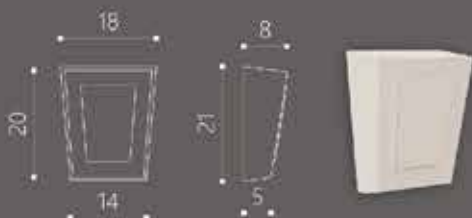

DR 10A



DR 11

R1615

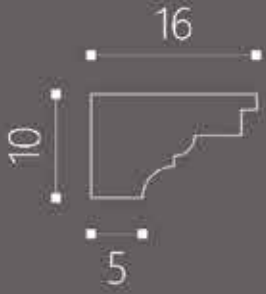

R1530

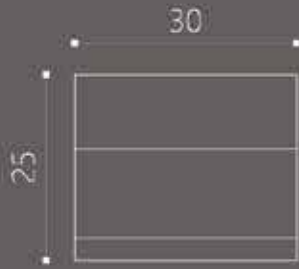

R2510

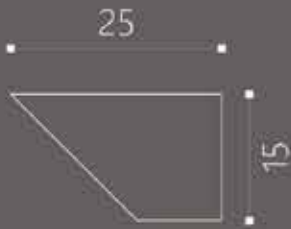



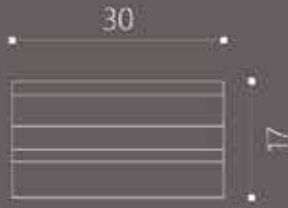
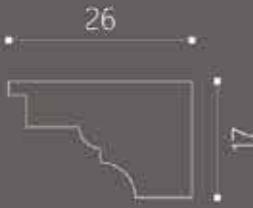





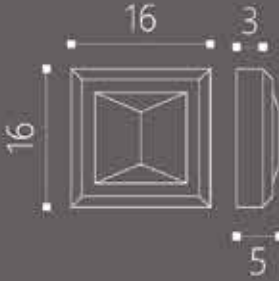

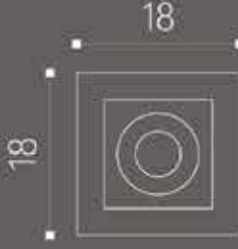



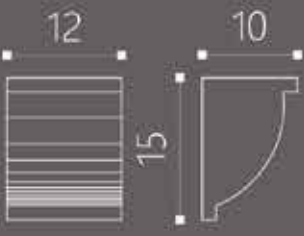





R2630

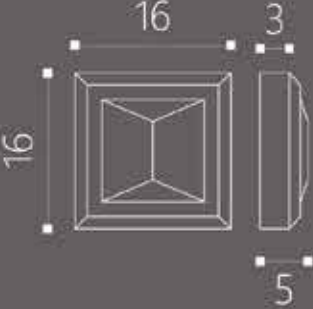

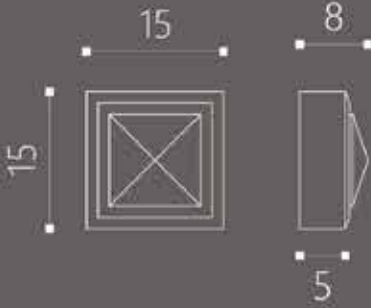
R3525

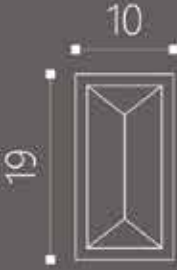

	 <p>DR2</p>
	 <p>DR8</p>
	 <p>DR22</p>
	 <p>R7</p>
	 <p>R1815</p>

DR3	 
DR7	 
DR7A	 
DR9	 
R5	 

	<p>R5A</p>
	<p>R3030</p>
	<p>R6061</p>
	<p>R120140</p>
	<p>R3</p>

R9



R11



PAYANDA 35

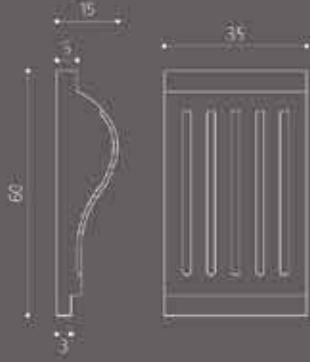

PAYANDA 60

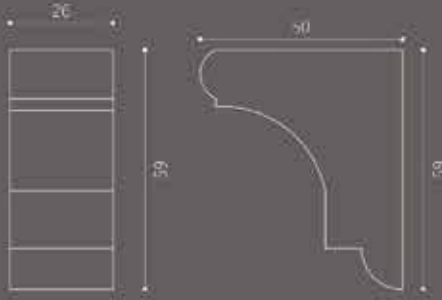

PAYANDA 120



PAYANDA 18



PAYANDA 34

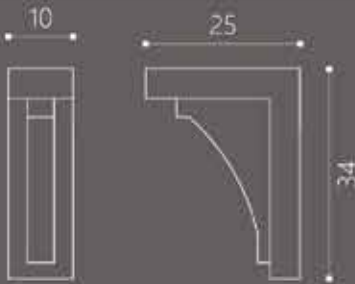



PAYANDA 216

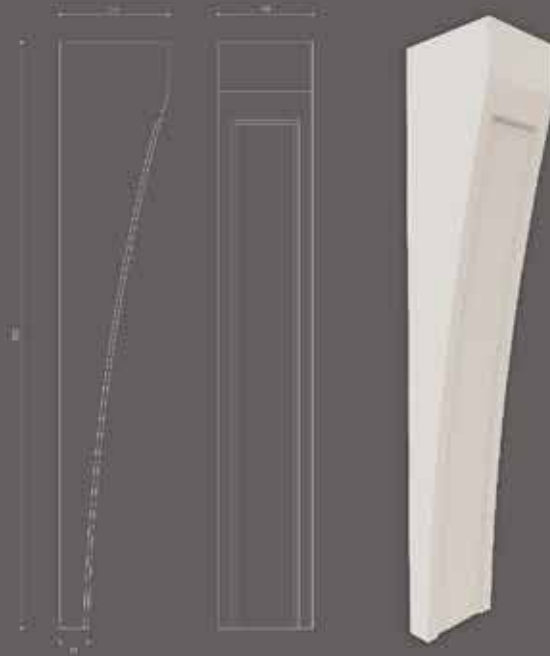

PAYANDA 300

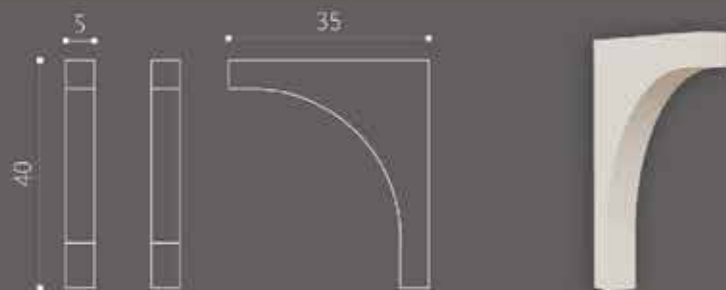

PAYANDA 40

PAYANDA 45

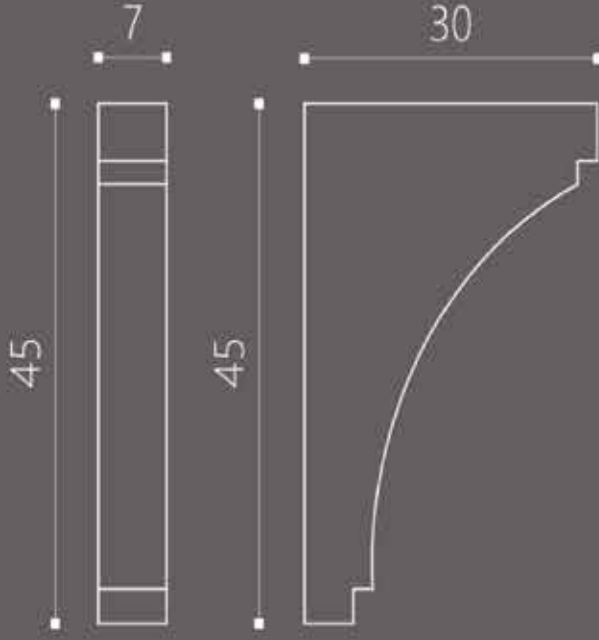

PAYANDA 80

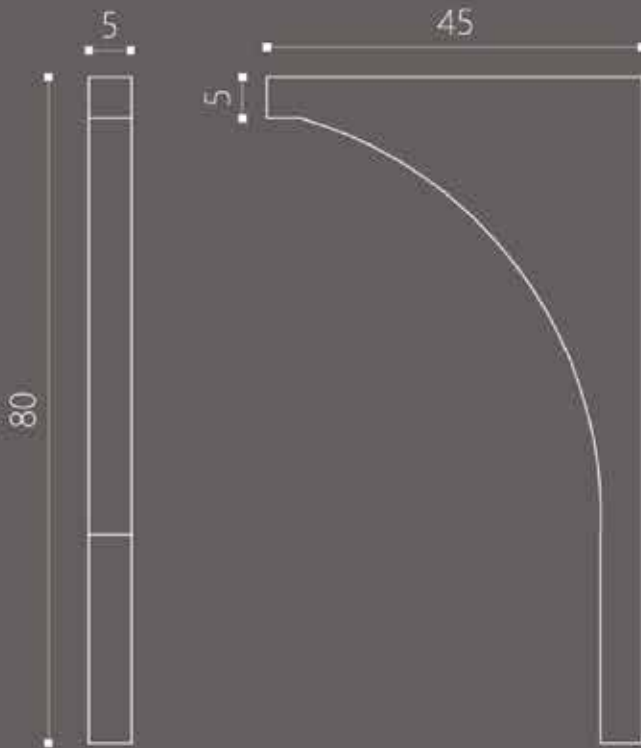

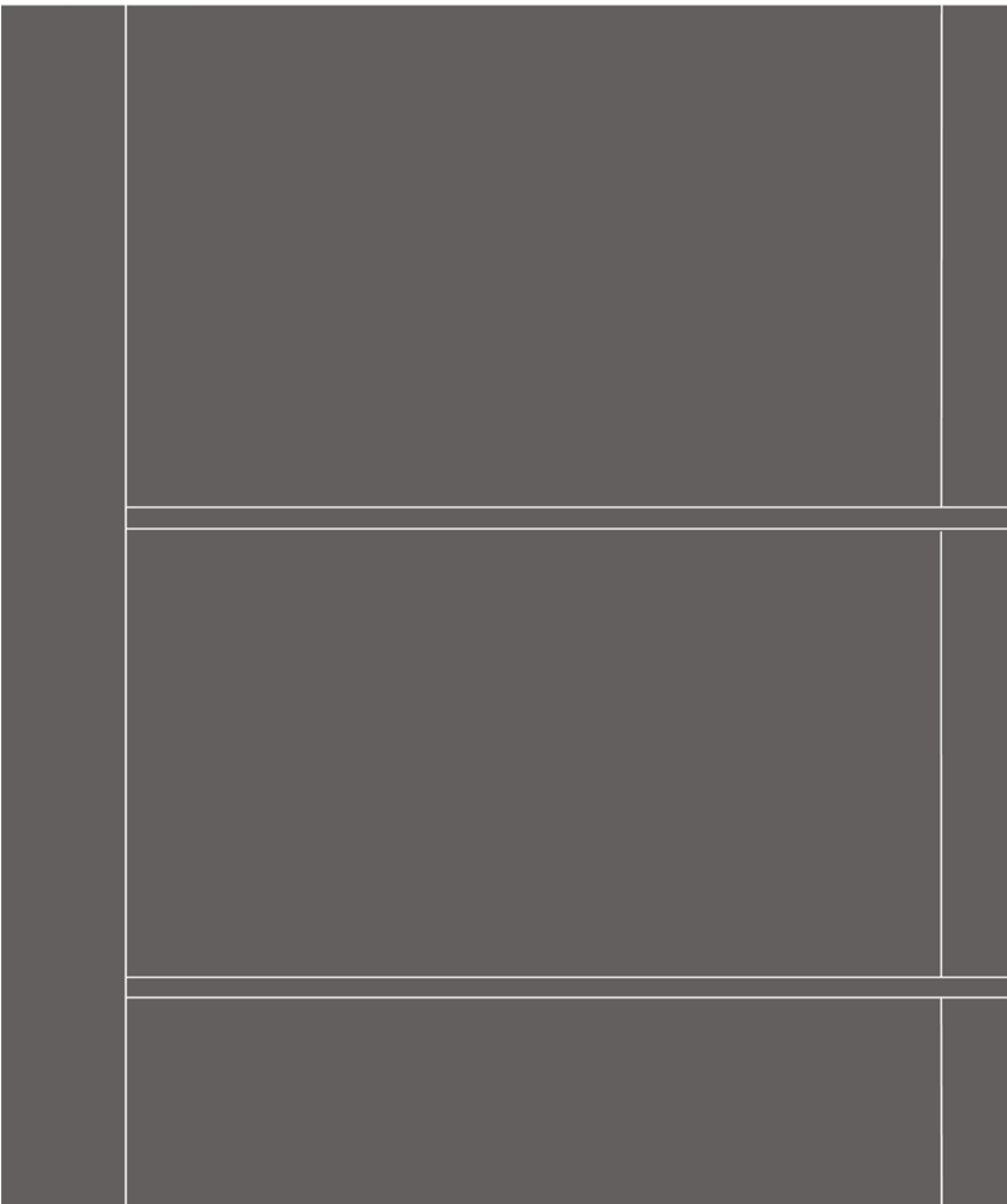

DR14

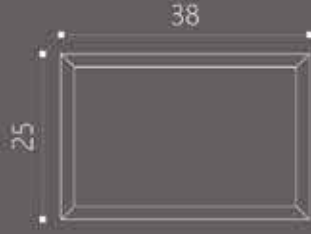

DR14A

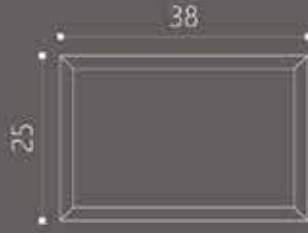

DR16

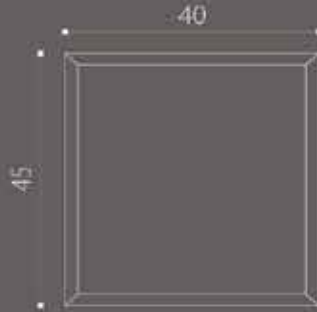

DR7455

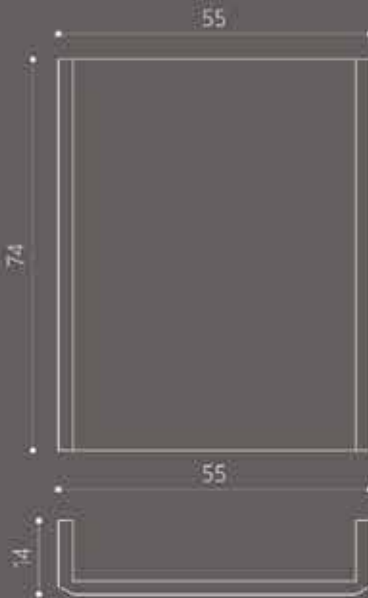

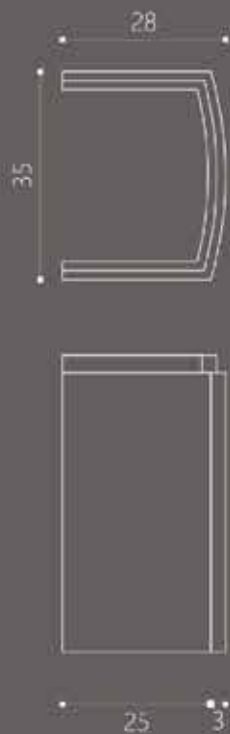
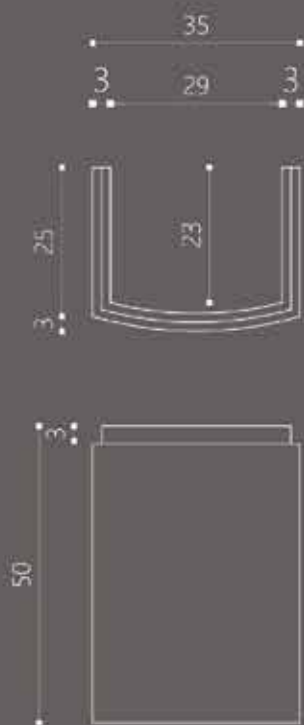



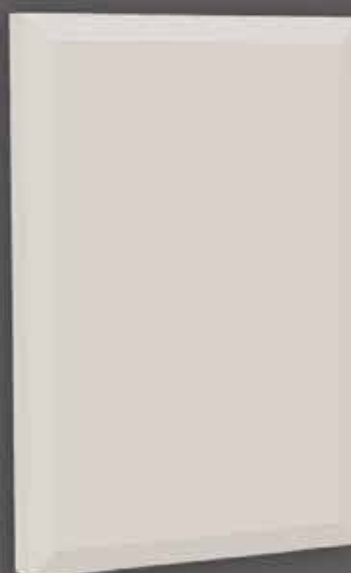
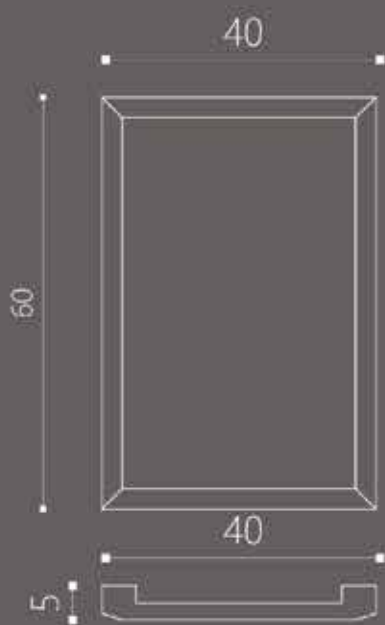



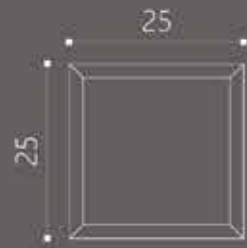

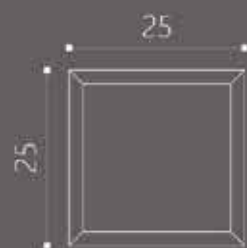

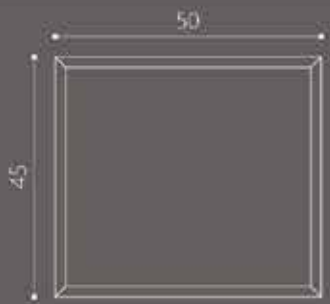
DR5035

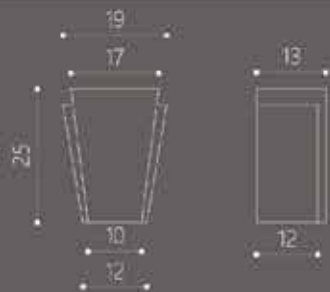

DR6040

DR12		
DR12A		
DR18		
DR25		
DR40		

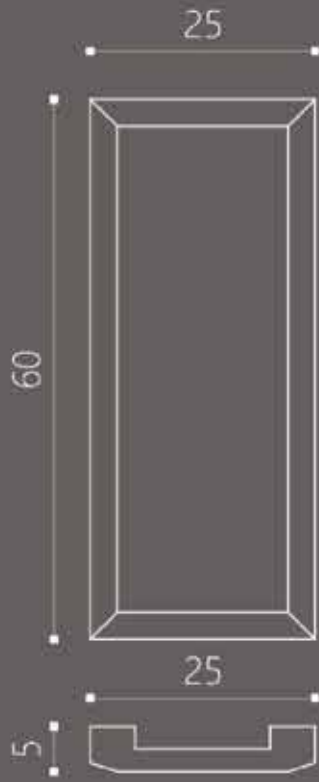

DR6025

PEDİMENT 20

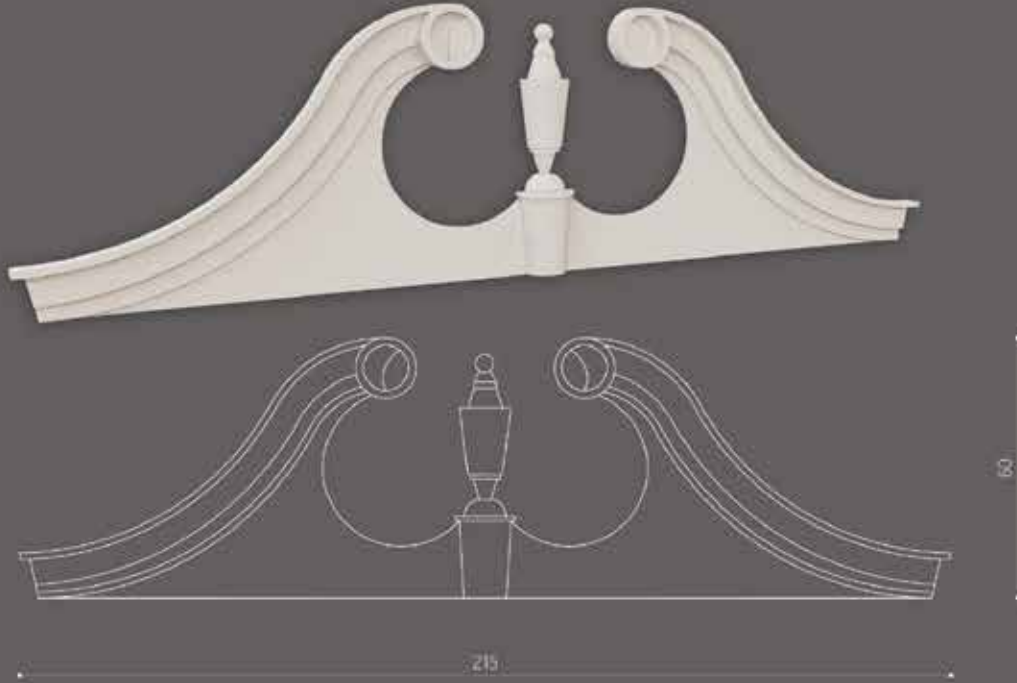

PEDİMENT 80

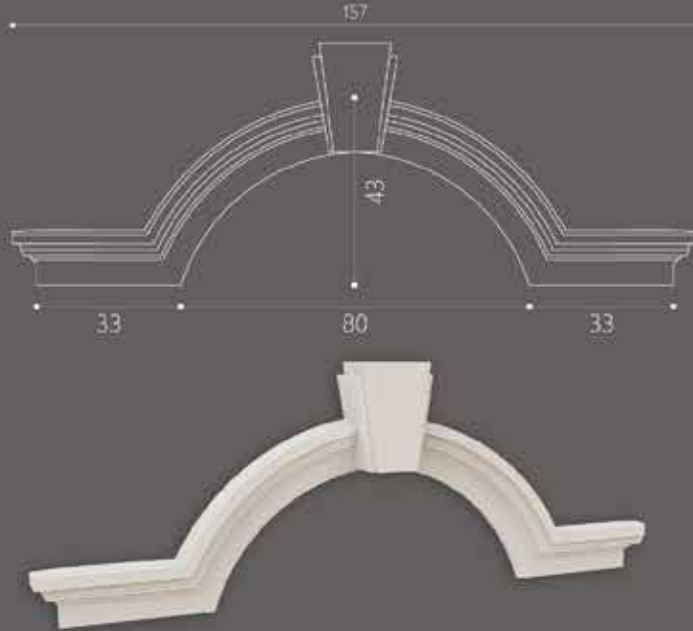

PEDİMENT 84

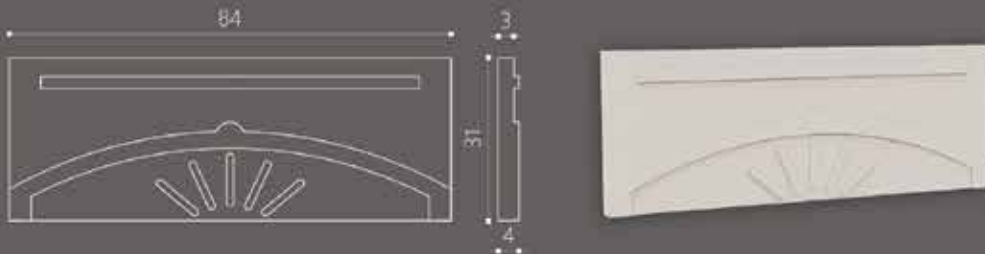

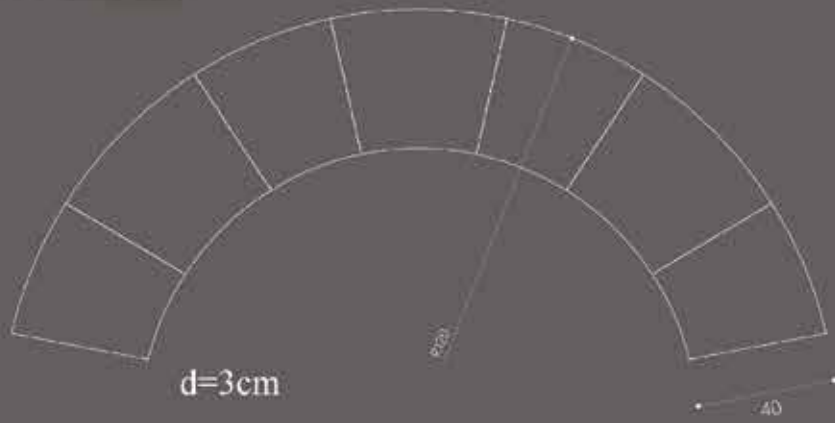
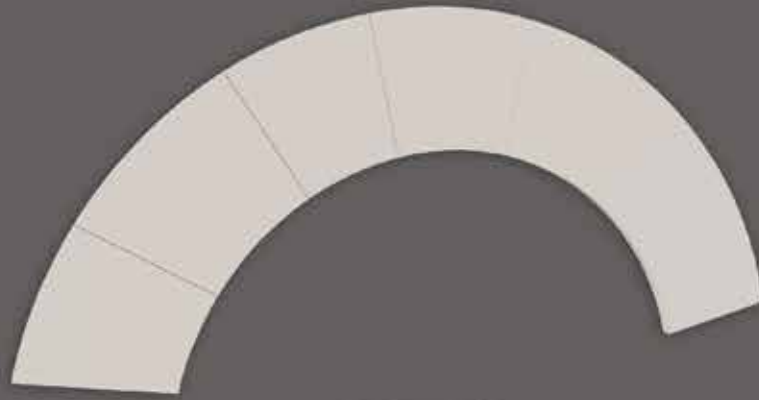

KEMER 120



KEMER 175

KEMER 260



PEDİMENT 220



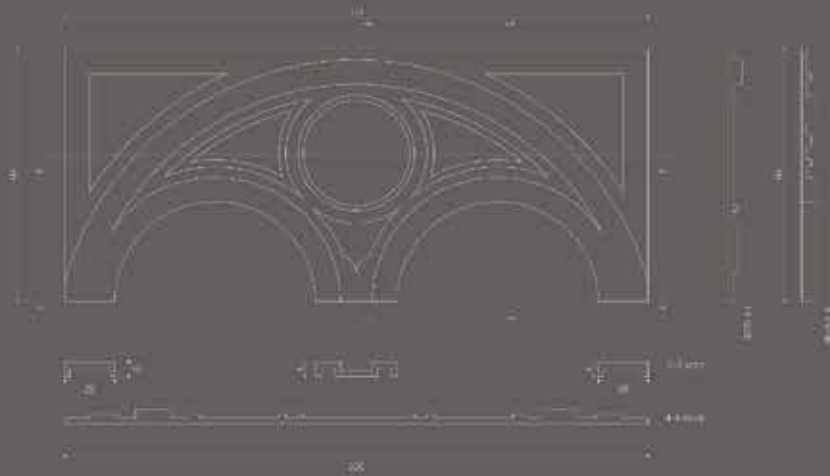

PEDIMENT 330

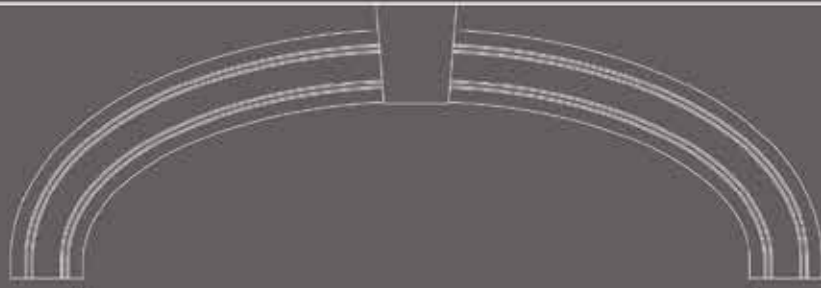

166



KEMER 166

KEMER 206

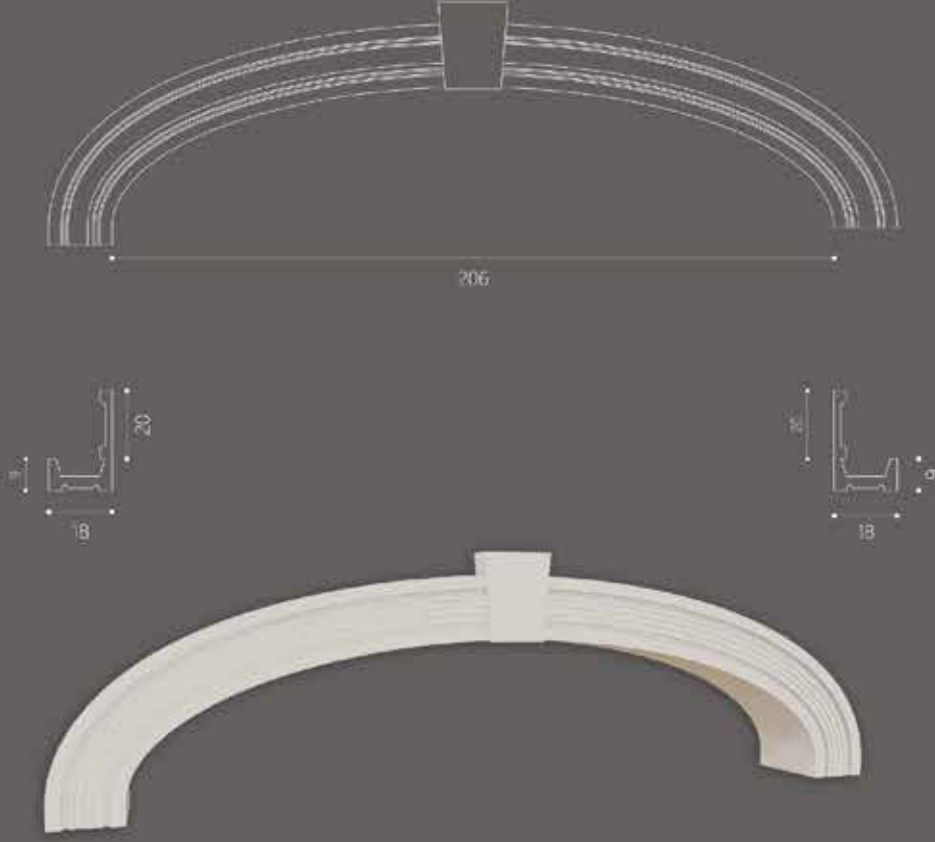

KEMER 70

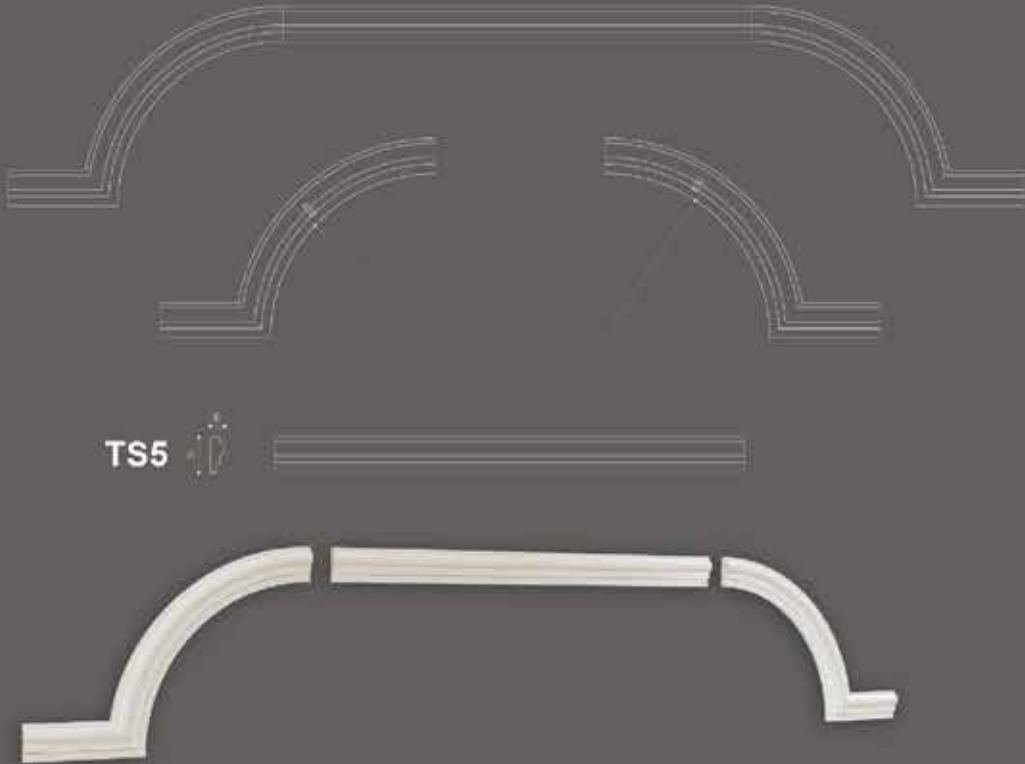



KEMER 220



P3

P5



P6



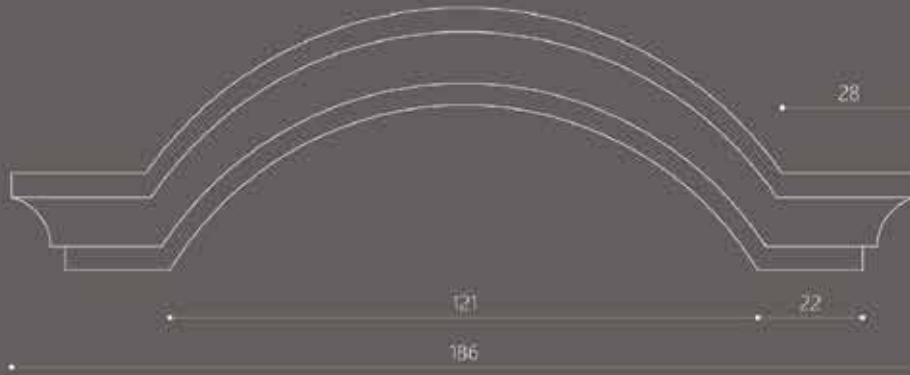

KEMER 121

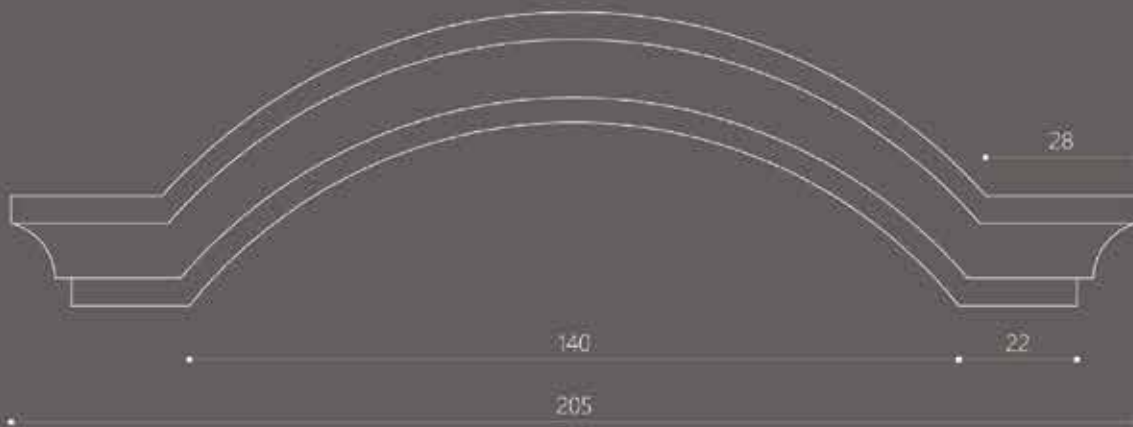

KEMER 140

KEMER 161

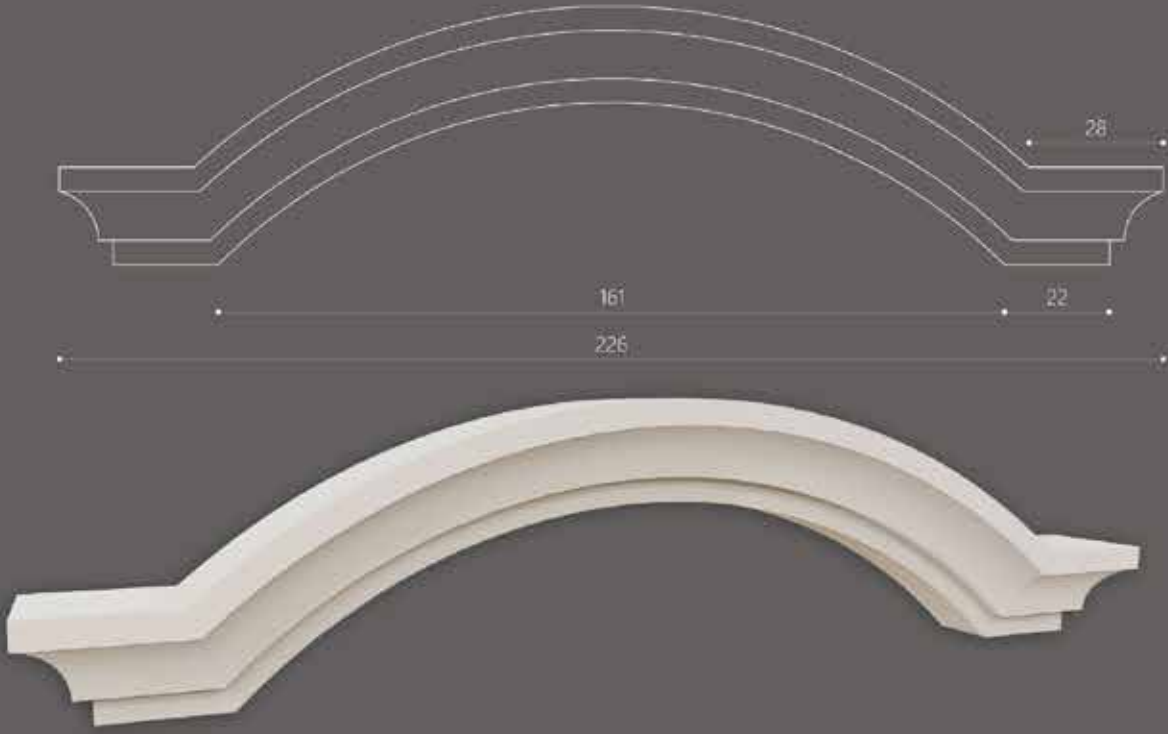



B6819



B7960



B8020





PLK 6060



PLK 950

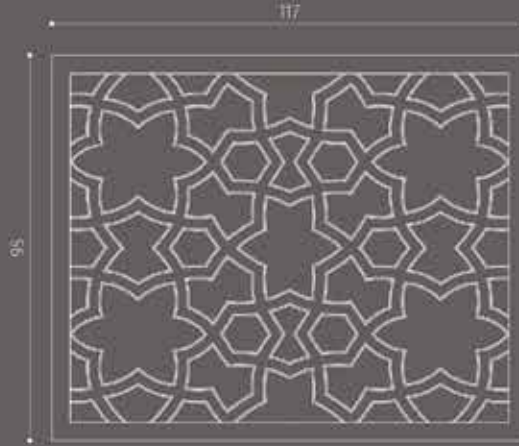
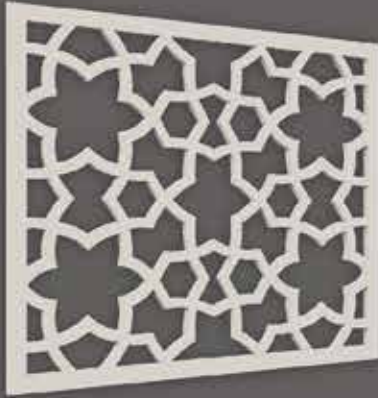

PLK 5858



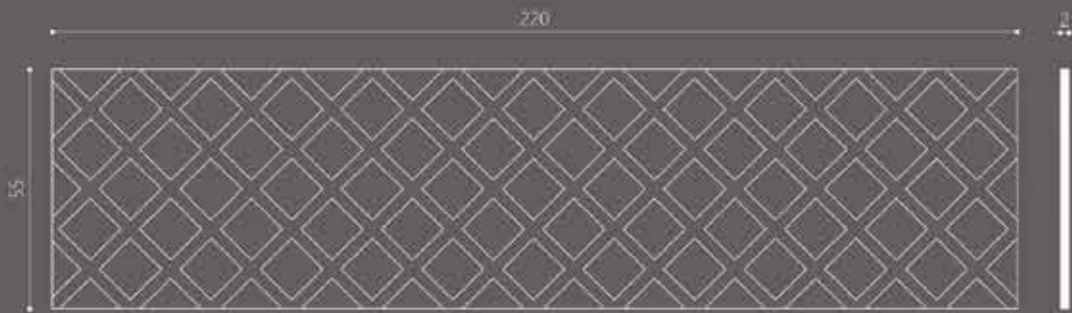

PLK 550

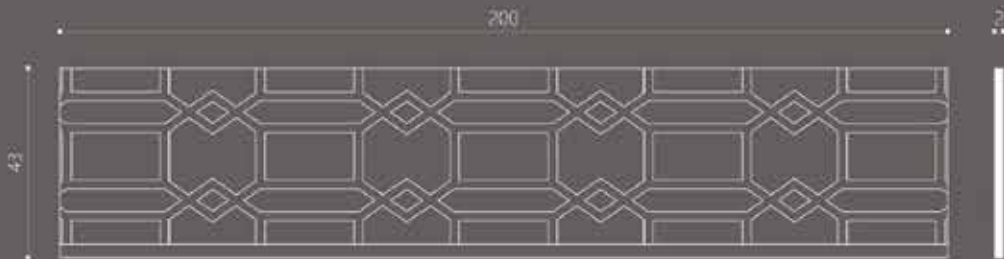

PLK - 430

PLK 430

PANEL 50CML250CM



L:250 CM



AĞAÇ DESEN



DÜZ LAMBRI





F1 PANEL

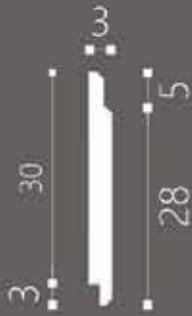

L:200 CM



PANEL 30CML200CM



YALI BASKI

F2 PANEL



PLK 40 x200

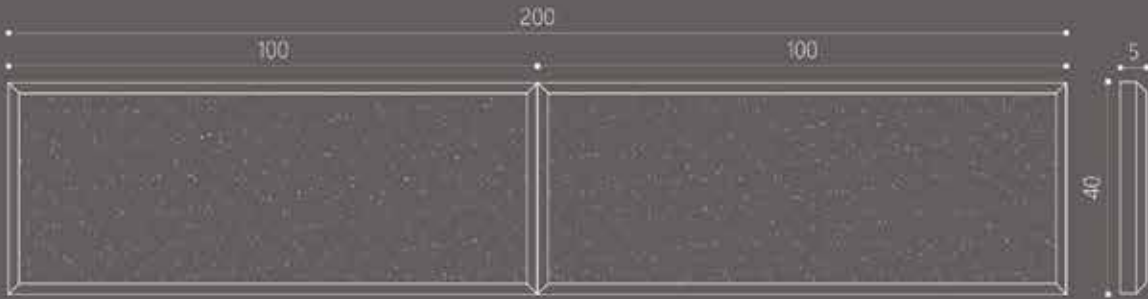

PLK - 40x200

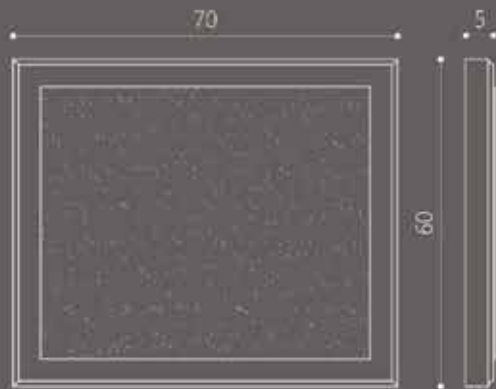

PLK - 70x60

PLK 70 x 60

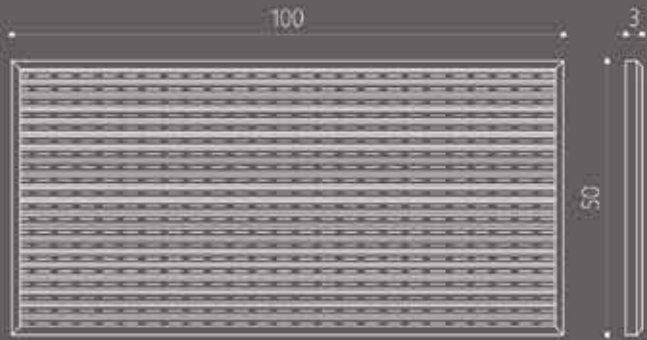

PLK - 100x50

PLK 100 x 50

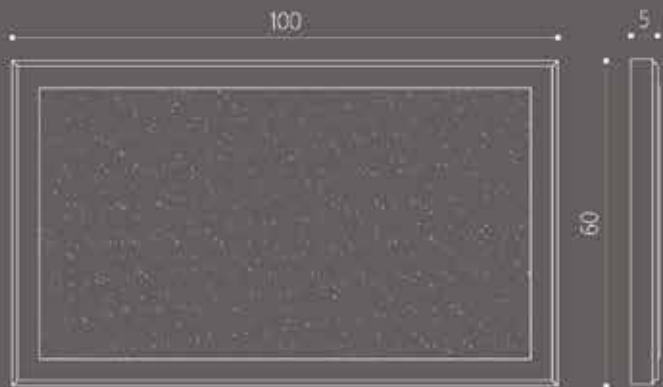

PLK - 100x60

PLK 100 x 60

PATLATMA TAŞ



190

45



PATLATMA TAŞ

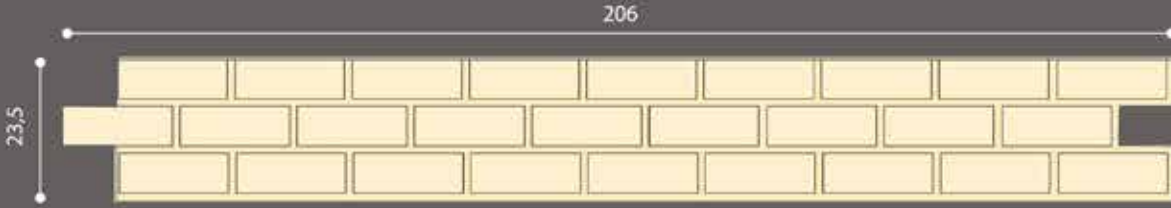

206

23,5

Kalınlık :1.8cm
Thickness: 1.8cm

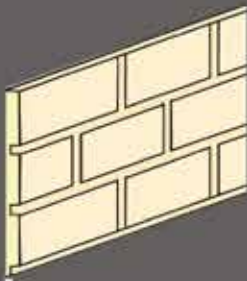

1.8



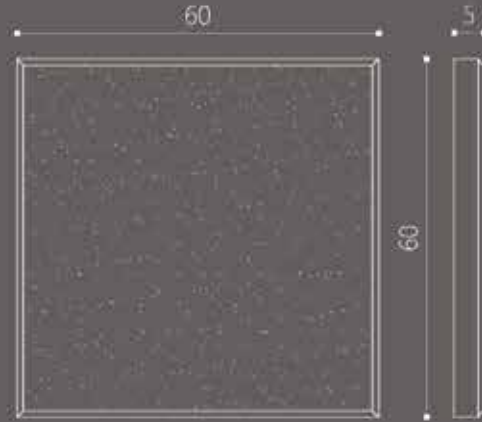
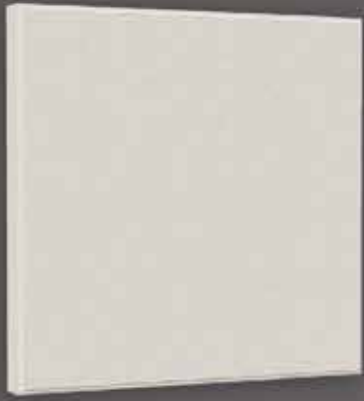

PLK - 60x60

PLK 60 x 60



PLK - 90x60

PLK 90 x 60

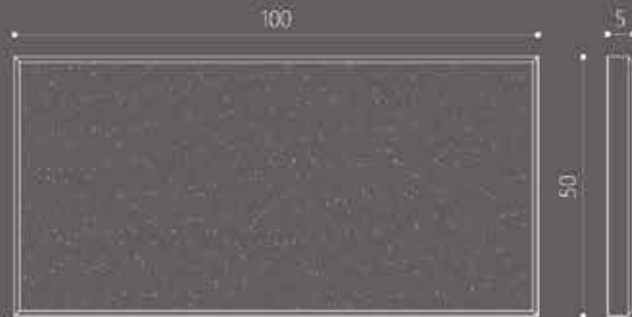

PLK - 100x50

PLK 100 x 50

PLK 100 x70

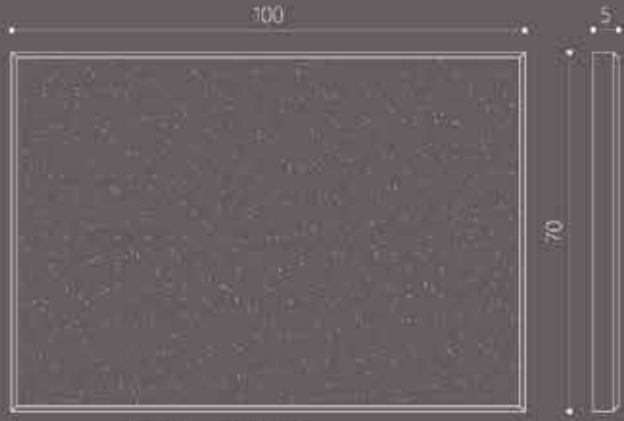

PLK - 100x70

KAYRAK TAŞI



KAYRAK TAŞI

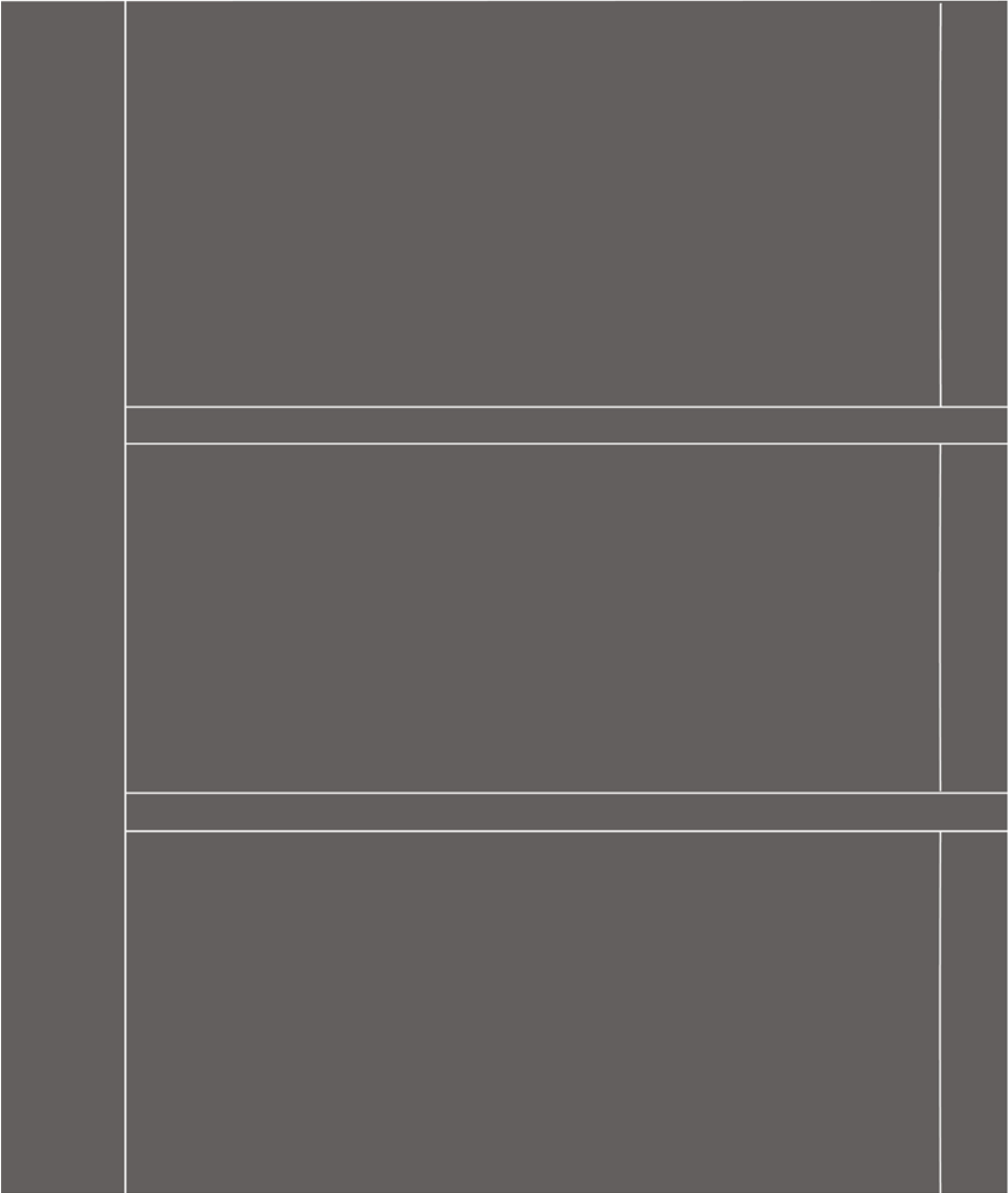



S220 B

38

15



S220

18

5



S220A

20



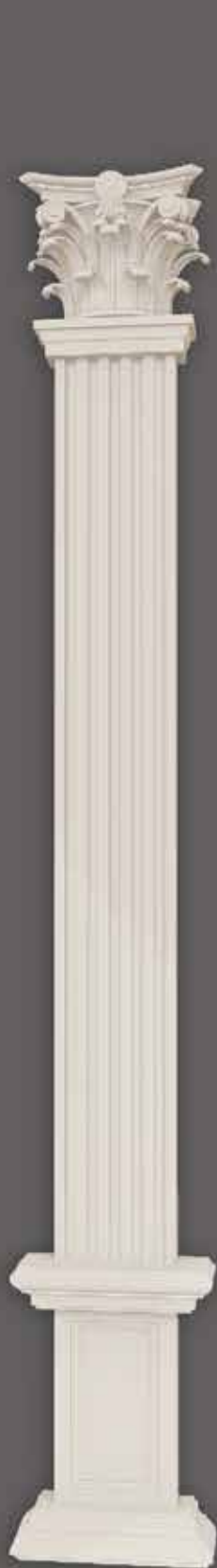

S330B

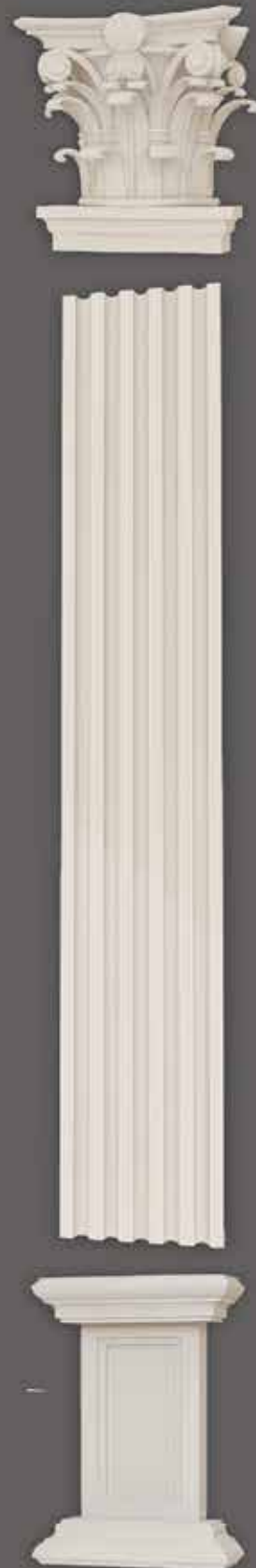

S330



S330A

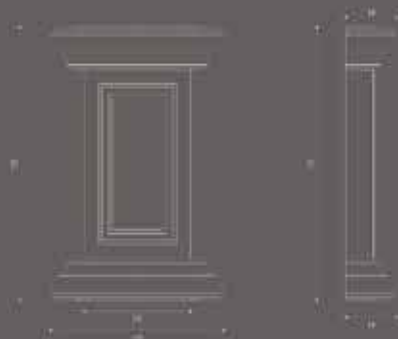



S335B



S335



S335A

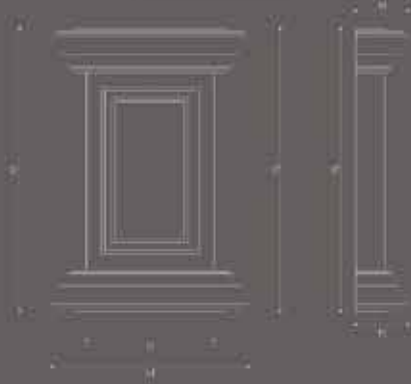



S500B

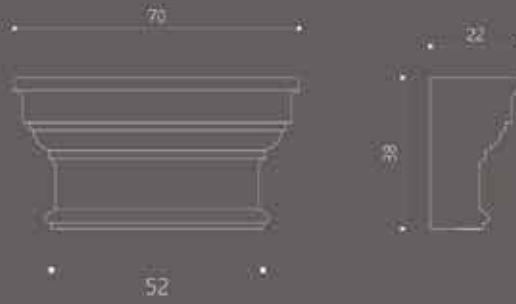

S500



S500A





S600B

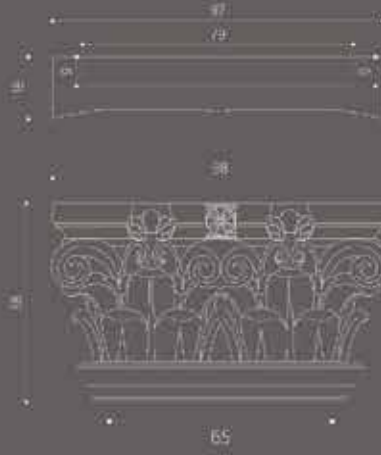

S600



S600A

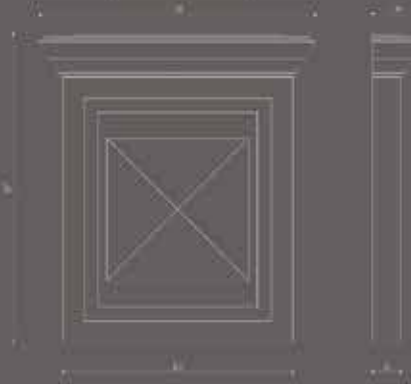



S860B



S860



S860A

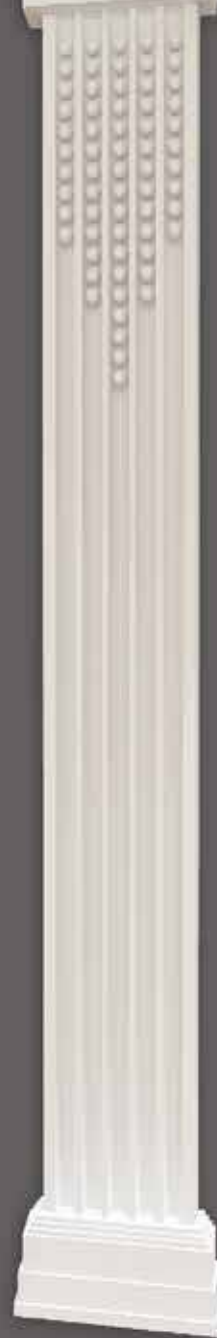



S 500 B

70



52

S 500-1

50



32

52

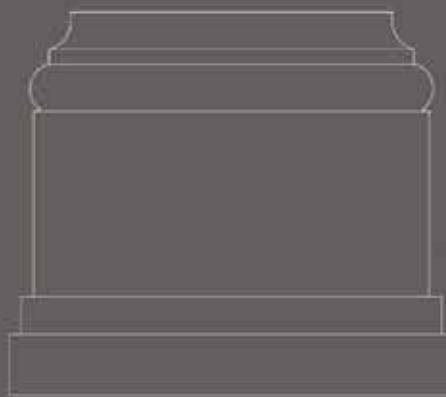

72

S 500 A1



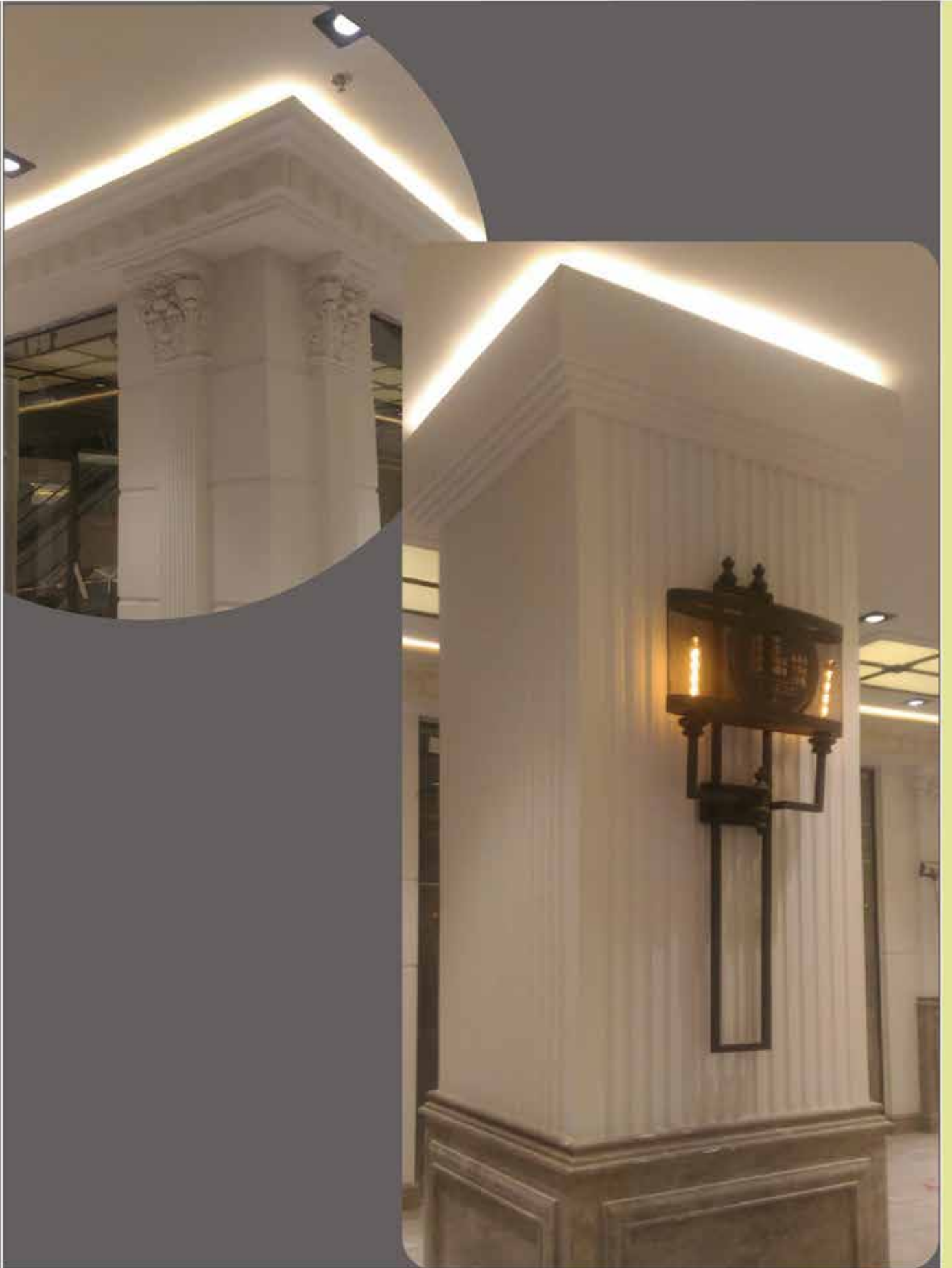



YS 200 B1

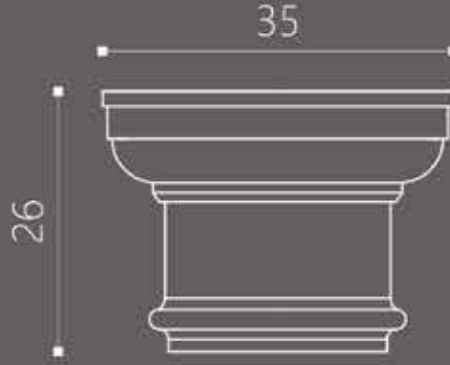

YS 200-1

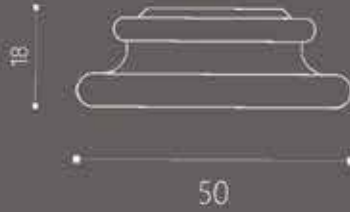

YS 200 A1





YS 300 B1

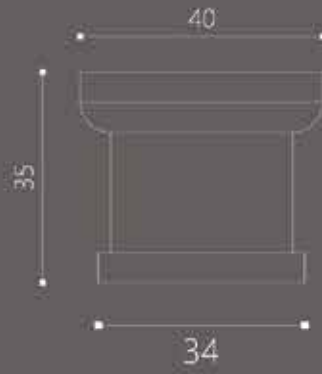

YS 300-1

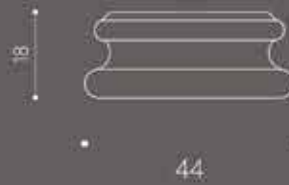

YS 300 A1





YS 300 B2



YS 300-2



YS 300 A1

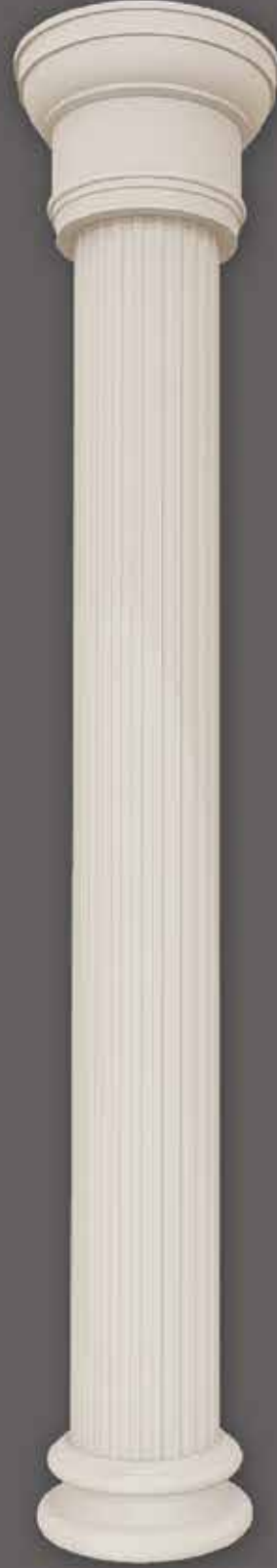



YS 300 B3



YS 300-2



YS 300 A1

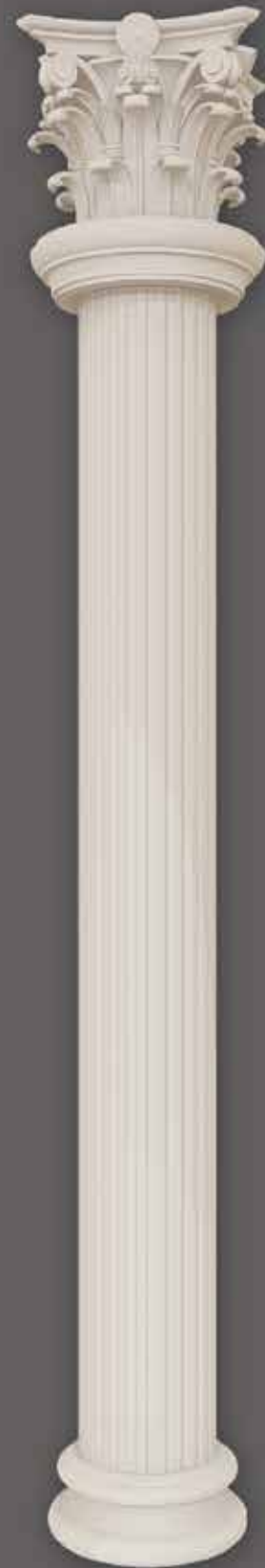



YS 300 B4

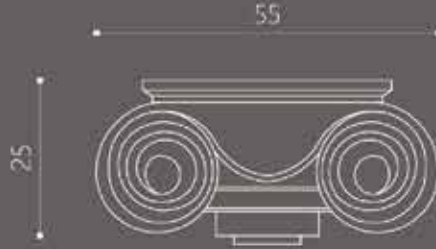

YS 300-2



YS 300 A1





YS 400 B1

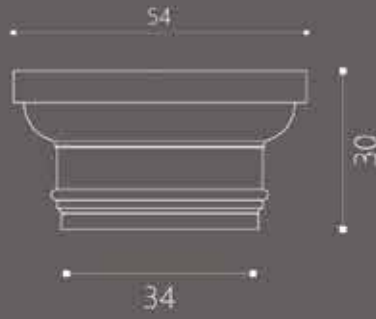

YS 400 1

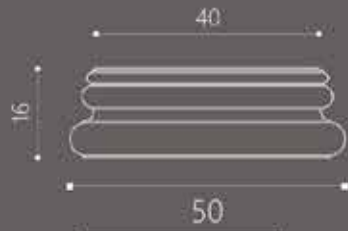
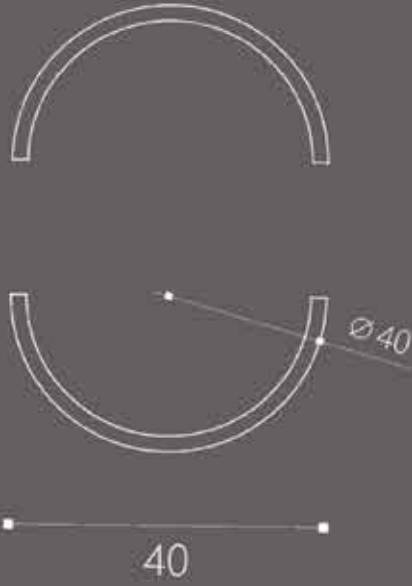

YS 400 A1





YS 400 B2



YS 400 1

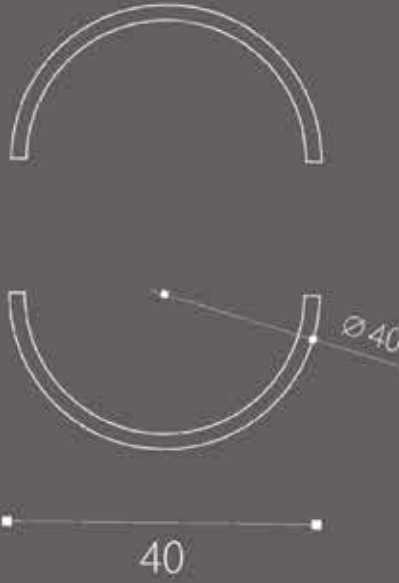

YS 400 A1

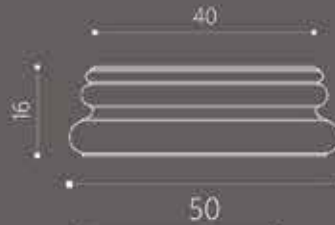



YS 400 B3

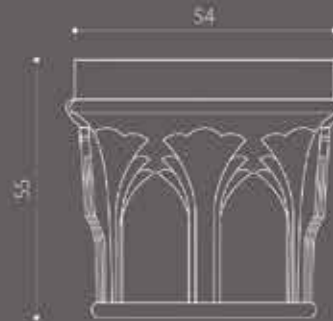
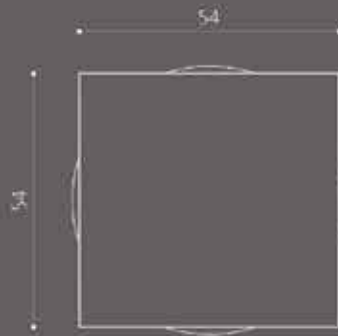

YS 400 B3



YS 400 A2





YS 500 B1



YS 500 A1 B1



50

YS 500 A1

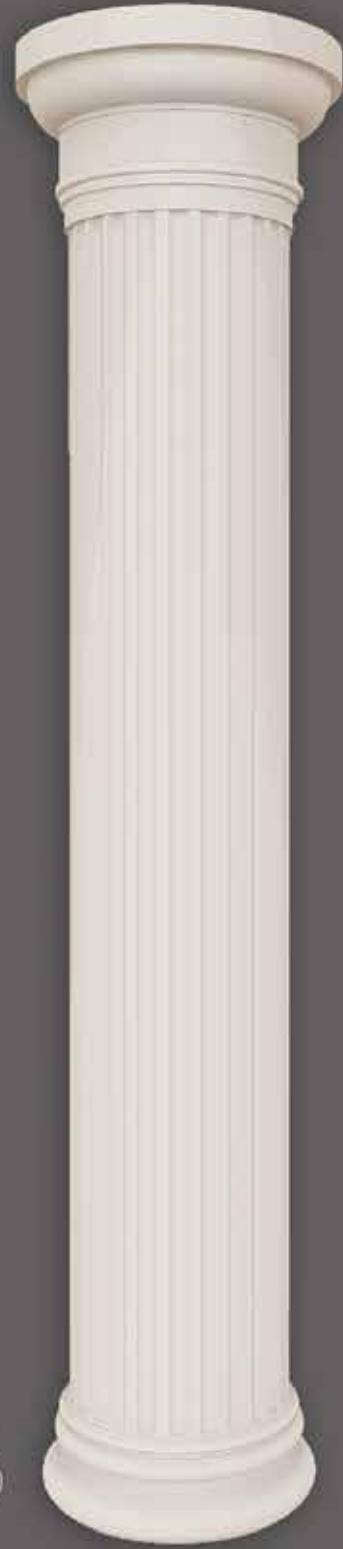
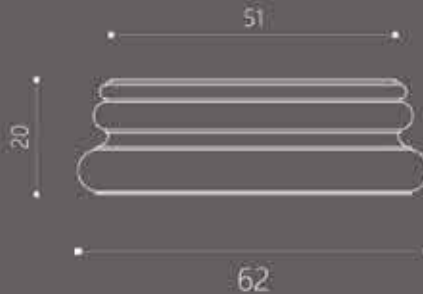



YS 700 B1

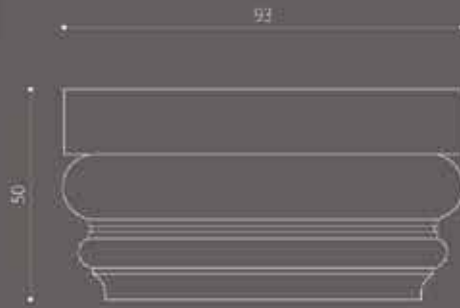

YS 700 A1





Fabrika: dps Dekorasyon Malzemeleri
İnş. Taah. San. ve Tic. Ltd. Şti.
Ödayerköyü / Kemerburgaz
İstanbul-Turkey

Phone: +90 212 206 51 52
Fax: +90 212 206 53 54
Mobile: +90 544 827 50 82
e-mail: info@dpsdekor.com

 #dpsdekor
www.dpsdekor.com

Showroom ve Mimari Ofis:
İzmitli OSB Maslak 5B Blok No: 28
Bağcısahiri-İstanbul/Türkiye

Phone: +90 212 548 55 55
Mobile: +90 555 055 21 80



DECORATION & PARTIENNE SYSTEMS

Aesthetics is Universal
Estetik Evrenseldir